



GERAND ENGINEERING

141 CHESHIRE LANE N, SUITE 100, MINNEAPOLIS MN 55441
952.374.1320 WWW.GERAND.COM

FIRE PUMP TEST METER G-750-5

CONSTRUCTION & SPECIFICATIONS

- VENTURI:** ZINC PLATED STEEL
- VALVES:** ONE PIECE BRASS BODY
ZINC DIECAST STEEL HANDLE
- ID TAG:** Chain: brass
Tag: Aluminum
- HOSES:** GOODYEAR 3/6" FREON CHARGE HOSES WITH NYTRILE CORE, POLYESTER BRAID AND NYTRILE COVER WITH PVC FOR ABRASION RESISTANCE

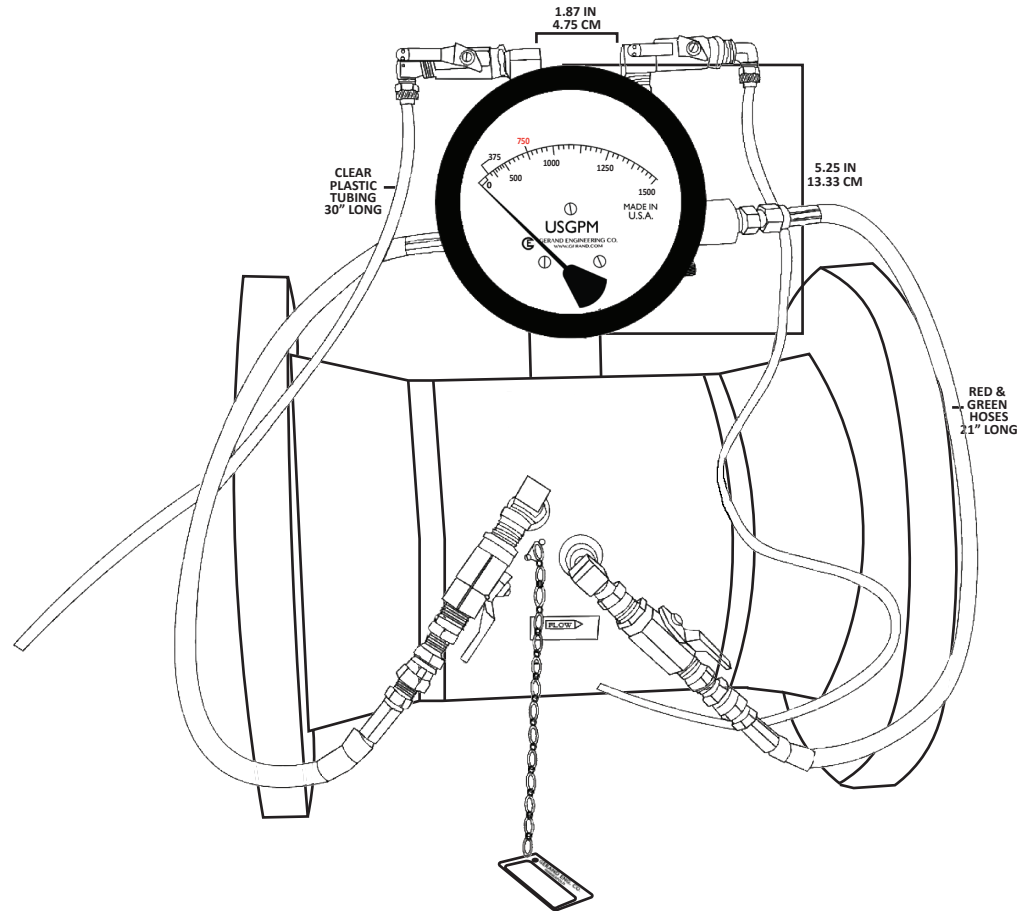

METER DATA

- CONSTRUCTION:** ALUMINUM BODY
- OPERATION:** BUNA "N" DIAPHRAGM
- ACCURACY:** ±2.0%
- TEMPERATURE:** 200° F MAX
- PRESSURE:** 1500 PSI MAX
- APPROX.WEIGHT:** 3 LBS/EACH

4 1/2" DIAL STANDARD - 6" AVAILABLE

WELD-NECK FLANGES
RAISED FACE

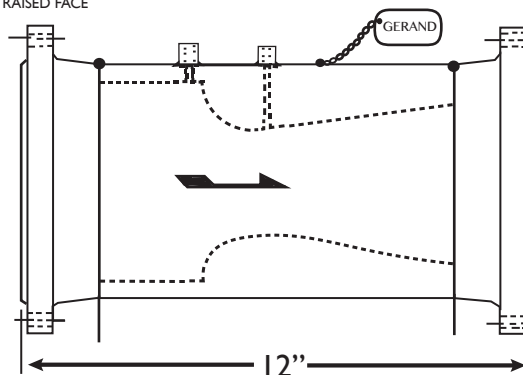

WEIGHTS & DIMENSIONS

- WEIGHT:** 55 LBS
- SHIPPING DIMENSIONS:** 13" x 13" x 21" BOX