



# GERAND ENGINEERING

2300 EDGEWOOD AVE S, MINNEAPOLIS, MN 55426  
952.374.1320 WWW.GERAND.COM

## FIRE PUMP TEST METER K-150-3

### CONSTRUCTION & SPECIFICATIONS

- MATERIALS:** CA36 ASTM B16 BRASS
- VALVES:** RATED AT 600 WOG  
**VALVE BODY:** CAST BRONZE ASTM B584  
**TAIL PIECE:** CA-360 B-16  
**BALL:** BRASS CA-360 HARD CHROME P  
**LATED SEALS:** REINFORCED PTFE, 15%  
**GLASS FILLED HANDLE:** STEEL ASTM B633  
 W/ZINC PLATING
- BRASS FITTING:** PIPE NIPPLE - B16 / 1/8" NEEDLE VALVE-B16  
 DISCONNECTS-B16
- ID TAG:** CHAIN: BRASS  
 TAG: ALUMINUM -3.21" THICK #200 MILL  
 SET SCREW: STEEL ZINC PLATED
- HOSES:** GOODYEAR 3/16" FREON CHARGING HOSES  
 WITH NYTRIEE CORE, POLYESTER BRAID  
 AND NYTRILE COVER WITH PVC  
 FOR ABRASION RESISTANCE.

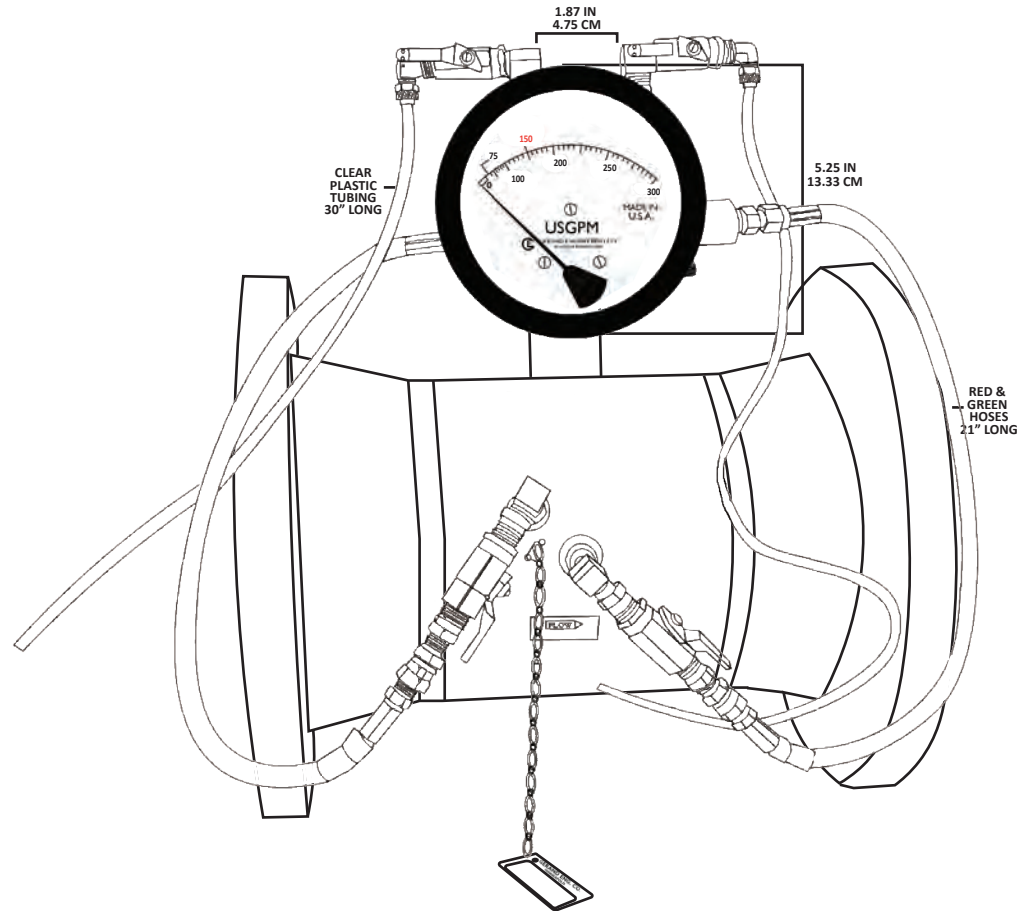

### METER DATA

- CONSTRUCTION:** ALUMINUM BODY
- OPERATION:** BUNA "N" DIAPHRAGM
- ACCURACY:** ±2.0%
- TEMPERATURE:** 200° F MAX
- PRESSURE:** 1500 PSI MAX
- APPROX. WEIGHT:** 3 LBS/EACH

4 1/2" DIAL STANDARD - 6" AVAILABLE

WELD-NECK FLANGES  
RAISED FACE

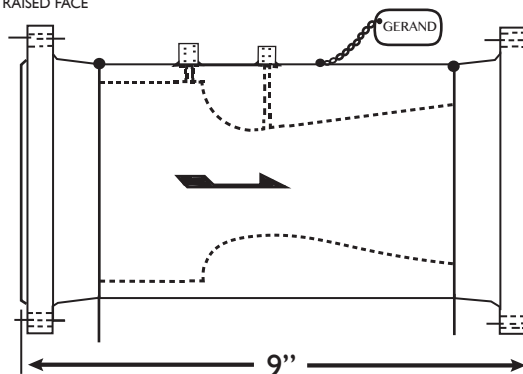

### WEIGHTS & DIMENSIONS

- WEIGHT:** 39 LBS
- SHIPPING DIMENSIONS:** 13" x 13" x 21" BOX