



GERAND ENGINEERING

2300 EDGEWOOD AVE S, MINNEAPOLIS, MN 55426
952.374.1320 WWW.GERAND.COM

FIRE PUMP TEST METER K-200-4

CONSTRUCTION & SPECIFICATIONS

- MATERIALS:** CA36 ASTM B16 BRASS
- VALVES:** RATED AT 600 WOG
VALVE BODY: CAST BRONZE ASTM B584
TAIL PIECE: CA-360 B-16
BALL: BRASS CA-360 HARD CHROME P
LATED SEALS: REINFORCED PTFE, 15%
GLASS FILLED HANDLE: STEEL ASTM B633
 W/ZINC PLATING
- BRASS FITTING:** PIPE NIPPLE - B16 / 1/8" NEEDLE VALVE-B16
 DISCONNECTS-B16
- ID TAG:** CHAIN: BRASS
 TAG: ALUMINUM -3.21" THICK #200 MILL
 SET SCREW: STEEL ZINC PLATED
- HOSES:** GOODYEAR 3/16" FREON CHARGING HOSES
 WITH NYTRIEE CORE, POLYESTER BRAID
 AND NYTRILE COVER WITH PVC
 FOR ABRASION RESISTANCE.

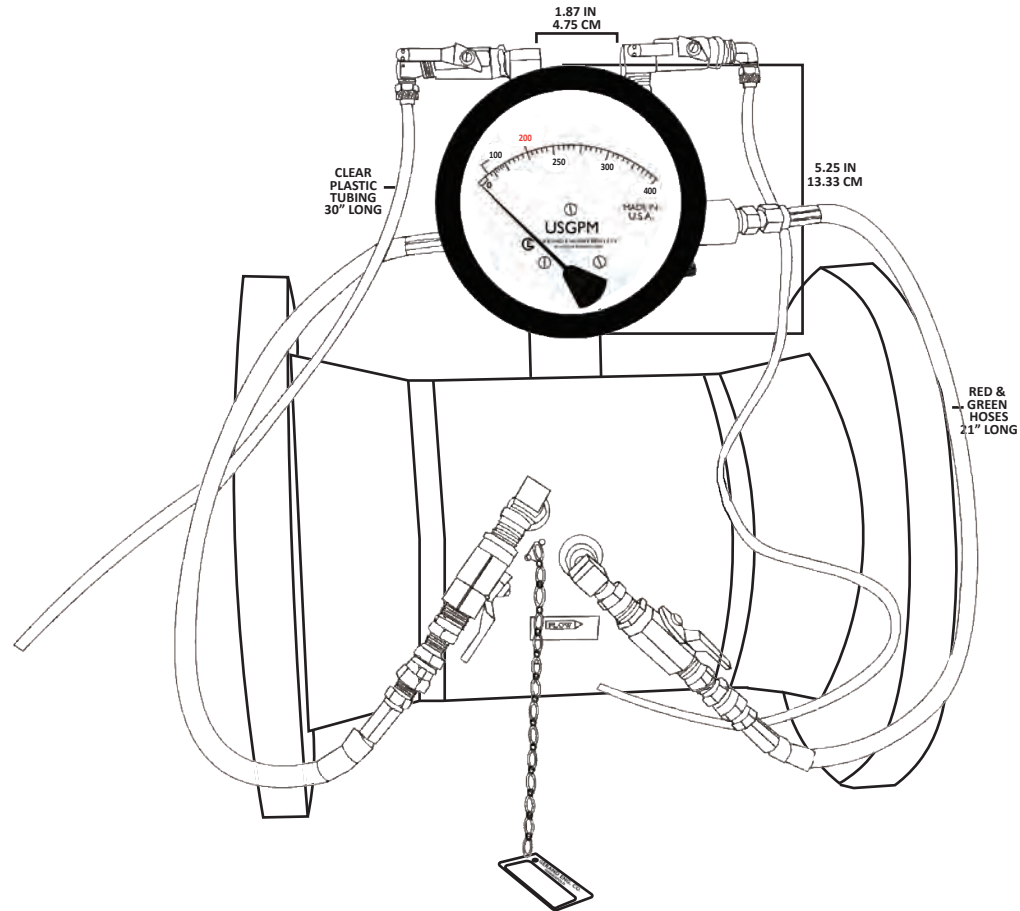

METER DATA

- CONSTRUCTION:** ALUMINUM BODY
- OPERATION:** BUNA "N" DIAPHRAGM
- ACCURACY:** ±2.0%
- TEMPERATURE:** 200° F MAX
- PRESSURE:** 1500 PSI MAX
- APPROX. WEIGHT:** 3 LBS/EACH

4 1/2" DIAL STANDARD - 6" AVAILABLE

WELD-NECK FLANGES
RAISED FACE

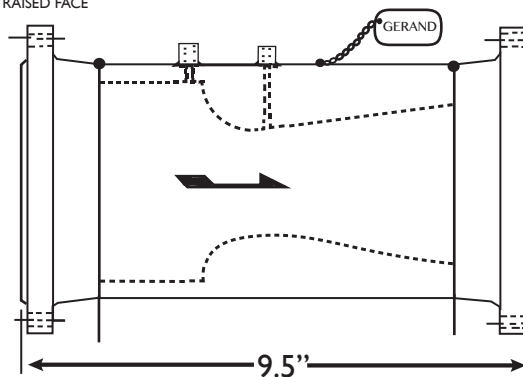

WEIGHTS & DIMENSIONS

- WEIGHT:** 51 LBS
- SHIPPING DIMENSIONS:** 13" x 13" x 21" BOX