

100

110

120

130

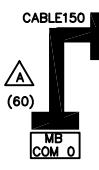
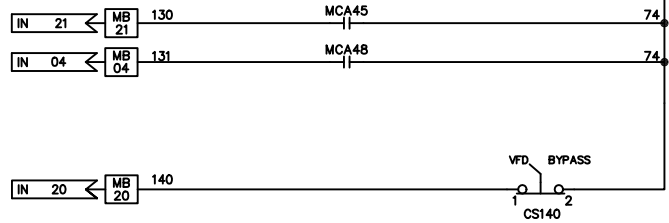
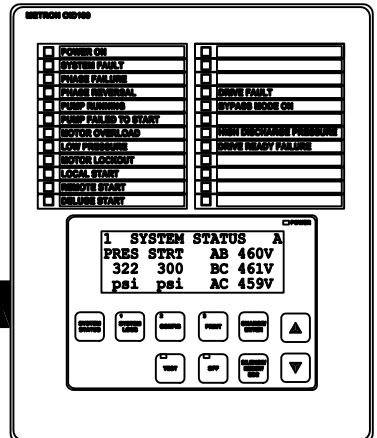
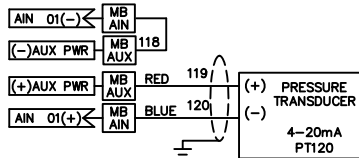
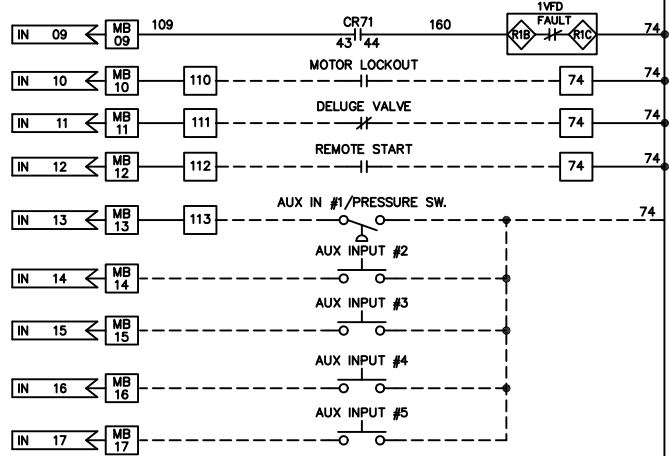
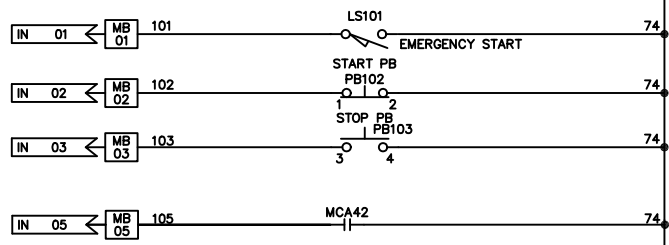
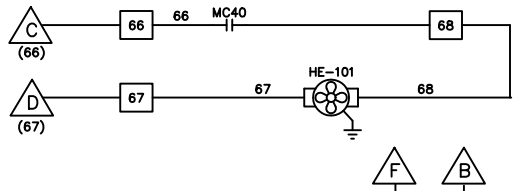
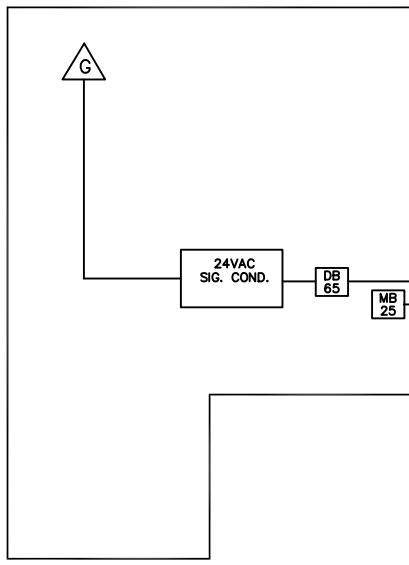

LEGEND:

- MB ## - MB = MB100 MOTHERBOARD I/O TERMINAL
- DB ## - DB = DB200 DAUGHTERBOARD I/O TERMINAL
- (1) - WIRES OR TERMINALS LOCATED ON CIRCUIT BREAKER

SCHEMATIC, MODEL MP800 VARIABLE FREQUENCY DRIVE ELECTRIC FPC W/AUTOTRANSFORMER BYPASS	DRAWN #2 02-14-06	METRON, INC. DENVER, CO.
	CHECK	
	APPD 77L.3C. 03-24-07	
	OPTIONS:H	
	CS34080A	
	SCALE NTS	SHEET 2 OF 3