



## Variable Frequency Drive

### SERIES MP800 VFD



Metron Fire Pump Controllers conform to the latest requirements of National Fire Protection Association's Standard for Centrifugal Fire Pumps as adopted by Underwriters Laboratories and Factory Mutual. They are short circuit withstand rated and listed by Underwriters Laboratories and approved by Factory Mutual Research Corporation.

Sizes range from 50 to 350 horsepower, 200 to 600 volts, 50 or 60 Hz. These controllers are for use on reduced voltage type installations.

Only the highest quality components, all UL listed or UL recognized, are used throughout to assure the best possible reliability. The cabinet is fabricated of heavy gauge reinforced steel with drip-proof hood. All field wiring and service connections may be made from the front, allowing the controller to be mounted flush against a wall.



*Controllers are completely wired, assembled, and tested at the factory before shipment and ready for immediate installation.*





## Standard and Optional Features



### Standard Features

- » NEMA Type 2 drip proof metal freestanding enclosure
- » Operator Interface Device (OID) with 4 lines by 20 character display with large character backlit Liquid Crystal Display (LCD) capable of being read in both direct sunlight or dark lighting conditions
- » 10 pushbuttons for easy screen navigation, LED lamp test, alarm reset, controller test and horn silencing
- » Removable labels to allow for easy field language changes
- » All controller settings are programmable through the OID. All features are enabled or disabled through the OID, no jumpers or external wires are needed allowing easy field modification
- » The system status data is displayed on the OID. The displayed items include: System pressure, Phase to Phase (AB, BC, AC) voltage, Phase current (A, B, C), Current time and date, System Events and Notifications such as Remote Start, Local Start etc., Number of starts, Total motor run hours, Time remaining on sequential motor start and motor stop timers, Status of automatic stop setting.
- » Auxiliary alarm functions displayed on the OID LCD screen
- » Audible horn with silence feature for silenceable alarms
- » Lamp test feature
- » Foreign languages selectable through the OID
- » Microprocessor based logic with real time/date clock capable of running a minimum of 14 days without AC power connected to controller
- » SD Memory card used to record pressure log, event and log, and auxiliary user programs. Pressure log is stored in separate comma delimited ASCII text files with each file containing data for one day. The SD card is removable and can be read by any PC equipped with an SD card reader.
- » Input and output status LED's provide visual indication of each discrete input's or output's on/off status
- » One RS485 Serial Port
- » MODBUS Communication Protocol via RS485 port
- » Service Entrance Rated

### Standard Auxiliary Alarms

The controller includes as standard six (6) discrete auxiliary inputs, nine (9) form 'C' auxiliary relay outputs. These auxiliary inputs and outputs are in addition to those mandated by NFPA 20. All auxiliary inputs, outputs, and OID Display can be field programmed through the OID.

Nine (9) of the following auxiliary alarms can be programmed and recorded in the event/alarm logs and annunciated on the OID display screen and/or output relay contact(s). These alarm conditions include:

- |                            |                       |
|----------------------------|-----------------------|
| LOW PUMP ROOM TEMP         | LOW PURGE PRESSURE    |
| RESERVOIR LOW              | LOW GEAR OIL PRESSURE |
| RESERVOIR EMPTY            | HIGH GEAR OIL TEMP    |
| RESERVOIR HIGH             | GAS DETECTION         |
| FLOW METER ON              | HIGH VIBRATION        |
| RELIEF VALVE OPEN          | EMERGENCY POWER ON    |
| LOW SUCTION PRESSURE       | PUMP ROOM DOOR OPEN   |
| LOW FIREWATER PRESSURE     |                       |
| HIGH PUMP ROOM TEMPERATURE |                       |





## Standard and Optional Features

### Data Logging

The controller includes two (2) separate data logs for storing system data that is readable through the OID or copied to a computer equipped with an SD card reader. The 2 data logs are as follows:

**Pressure Log:** The pressure log provides a continuous pressure record for 30 days. The pressure log samples shall be time and date stamped and stored in permanent non-volatile SD memory card. The pressure log can be searched by each sample, by minute, or by hour through the OID.

**Event Log:** The event log will store up to 300 of the most current events. These events can include, but is not limited to, any of the following events/alarms:

- PUMP RUNNING
- POWER AVAILABLE
- PHASE REVERSAL
- MOTOR OVERLOAD
- REMOTE START
- LOCAL START
- PUMP ON DEMAND
- SYSTEM FAULT
- PRESSURE TRANSDUCER FAULT
- PUMP FAILED TO START
- LOW INTAKE SHUTDOWN ALARM
- SUPERVISORY POWER FAILURE
- LOW PRESSURE
- AUTO WEEKLY TEST START
- UNDER FREQUENCY
- OVER FREQUENCY
- LOW ZONE/ HIGH ZONE CONTACTS
- HIGH DISCHARGE PRESSURE
- NO LOAD CONDITION

### Model Number Designation

**Example: MP800-H-75-480C**

**MP800** -- Model Type

- **X** -- Option Designation(s)

- **XXX** -- Horsepower Rating: 50-350

- **XXX** -- Voltage Rating: 200-600 VAC

**X** -- Withstand Rating: B - 22,000 (@575 VAC) 50,000 (200-480 VAC)  
C - 100,000 (200-480 VAC)

**Information required with order:** 1) Model Type 2) Motor Horsepower 3) Line Voltage, phase and frequency 4) Options, if any (complete description)

### Options

#### Option H: Space Heater

If the ambient atmosphere is especially damp, a space heater rated at 100 watts may be supplied to reduce moisture in the cabinet. A thermostat is supplied as standard with this option. A humidistat may be substituted if specified.

#### Option W: Omit Legs

For systems where the controller is mounted on a common skid with the pump and motor, the legs of the controller may be omitted, 3" (76.2mm) channels or wall mounting brackets can be supplied. If specified, lifting eyes may also be supplied.

#### Enclosure

The following NEMA type enclosures are also available: 3R, 4, 4X (Painted Cold Rolled Steel), 4X (304 or 316 Stainless Steel), and 12.

Consult factory for additional options.

### Standard Withstand Ratings

VOLTS	HP -- RMS SYMMETRICAL
200-208	15-150 -- 100kA
220-240	15-200 -- 100kA
380-415	15-300 -- 100kA
460-480	15-400 -- 100kA
200-208	200-250 -- 50kA
220-240	250-300 -- 50kA
380-415	350-350 -- 50kA
460-480	500-600 -- 50kA
550-600	15-400 -- 22kA





## Specifications

### General Controller Description

The Fire Pump Controller shall be factory assembled, wired and tested as a unit and shall conform to all requirements of the latest edition of NFPA 20 and by Third Party Listed by Underwriters Laboratories (UL) and Approved by Factory Mutual (FM). The controller shall be available for 208, 230, 380-415, 480, or 575-600 volt three phase power.

### Controller Equipment Features

The controller shall include the following standard features:

- » NEMA Type 2 drip proof metal freestanding enclosure
- » Operator Interface Device (OID) with 4 lines by 20 character display with large character backlit LCD capable of being read in both direct sunlight or dark lighting conditions
- » 10 pushbuttons for easy screen navigation, system test, lamp test, alarm reset, and horn silencing
- » Multicolored LED's for alarm and mode annunciation
- » LEDs shall be labeled with removable labels to allow for easy field modification of language changes
- » All controller settings shall be programmable through the OID and shall be protected by two password levels
- » All features shall be enabled or disabled through the OID, no jumpers or external wires shall be needed or allowed to activate or deactivate a feature
- » The system status data shall be displayed on the OID. The displayed items shall include: System pressure, Phase to Phase (AB, BC, AC) voltage, Phase current (A, B, C), System Events and Notifications, Current time and date, Number of starts, Total motor run hours, Displayed countdown timers for: Sequential motor start and motor stop, Status of Automatic Stop Setting.
- » Audible horn with silence feature for silencable alarms
- » Lamp test feature
- » Foreign languages selectable through the OID
- » One RS485 Serial Port
- » MODBUS Communication Protocol via RS485 port
- » All wiring terminals on PCB's shall be removable type
- » Service Entrance Rated

- » Microprocessor based logic with real time/date clock capable of running a minimum of 14 days without AC power connected to controller and non-volatile flash memory to permanently store the continuous pressure log, event log, alarm log and all user changeable set points and system data. Battery backup of any kind not allowed.
- » Input and output status LED's to provide visual indication of each discrete input's or output's on/off status

### Auxiliary Alarms

As standard the controller shall include 6 discrete auxiliary inputs, 9 form 'C' auxiliary relay outputs. These auxiliary inputs and outputs are in addition to those mandated by NFPA 20. All auxiliary inputs, outputs, and OID screens shall be field programmable through the OID. This permits a multitude of customizable controller configurations to meet each installations unique needs without adding cost to the controller. The use of jumpers, soldering, or other external components are not allowed.

The user can select any 9 of the following auxiliary alarms that can be programmed and recorded in the event log and annunciated with an OID screen and output relay contact for conditions such as but not limited to:

- LOW PUMP ROOM TEMP
- RESERVOIR LOW
- RESERVOIR EMPTY
- RESERVOIR HIGH
- FLOW METER ON
- RELIEF VALVE OPEN
- LOW SUCTION PRESSURE
- HIGH PUMP ROOM TEMPERATURE
- LOW FIREWATER PRESSURE
- LOW PURGE PRESSURE
- LOW GEAR OIL PRESSURE
- HIGH GEAR OIL TEMPERATURE
- GAS DETECTION
- HIGH VIBRATION
- EMERGENCY POWER ON
- PUMP ROOM DOOR OPEN

### Data Logging

The controller shall have separate data logs for storing system data that is readable through the OID.

**Pressure Log:** The controller shall have a Pressure log with continuous pressure recording of 30 days of data. The pressure log samples shall be time and date stamped and stored on a removable SD card memory. The pressure log shall be searchable by each sample, by minute, or by hour. Each days entries shall be stored in a separate file on the SD card. SD memory shall be readable by any PC equipped with an SD memory card reader.

**Event Log:** The event log shall be capable of storing no less than 3000 events. These events shall include, but is not limited to, any of the following events/alarms:

- PUMP RUNNING
- POWER AVAILABLE
- PHASE REVERSAL
- MOTOR OVERLOAD
- REMOTE START
- LOCAL START
- PUMP ON DEMAND
- SYSTEM FAULT
- PRESSURE TRANSDUCER FAULT
- PUMP FAILED TO START
- LOW INTAKE SHUTDOWN ALARM
- SUPERVISORY POWER FAILURE
- LOW PRESSURE
- AUTO WEEKLY TEST START
- UNDER FREQUENCY
- OVER FREQUENCY
- LOW ZONE / HIGH ZONE CONTACTS
- HIGH DISCHARGE PRESSURE
- NO LOAD CONDITION

Each event or alarm recorded in the event log shall have the following data recorded with the event/alarm:

- Time and Date of Event or Alarm
- System Pressure
- Descriptive Text Message of the Event/ Alarm
- Motor Running Status
- Phase to Phase Volts
- Phase Amps

The internal logic of the controller shall be capable of operation in a temperature range of 4.4°C to 50°C and high, non-condensing, humidity levels.

Controllers shall be manufactured by Metron - A Division of Hubbell Industrial Controls, Inc.

[www.metroninc.com](http://www.metroninc.com)



Hubbell Industrial Controls, Inc. • 4301 Cheyenne Dr., Archdale, NC 27263  
PH: 336-434-2800 • FAX: 336-434-2801 • Email: [salesmail@metroninc.com](mailto:salesmail@metroninc.com)



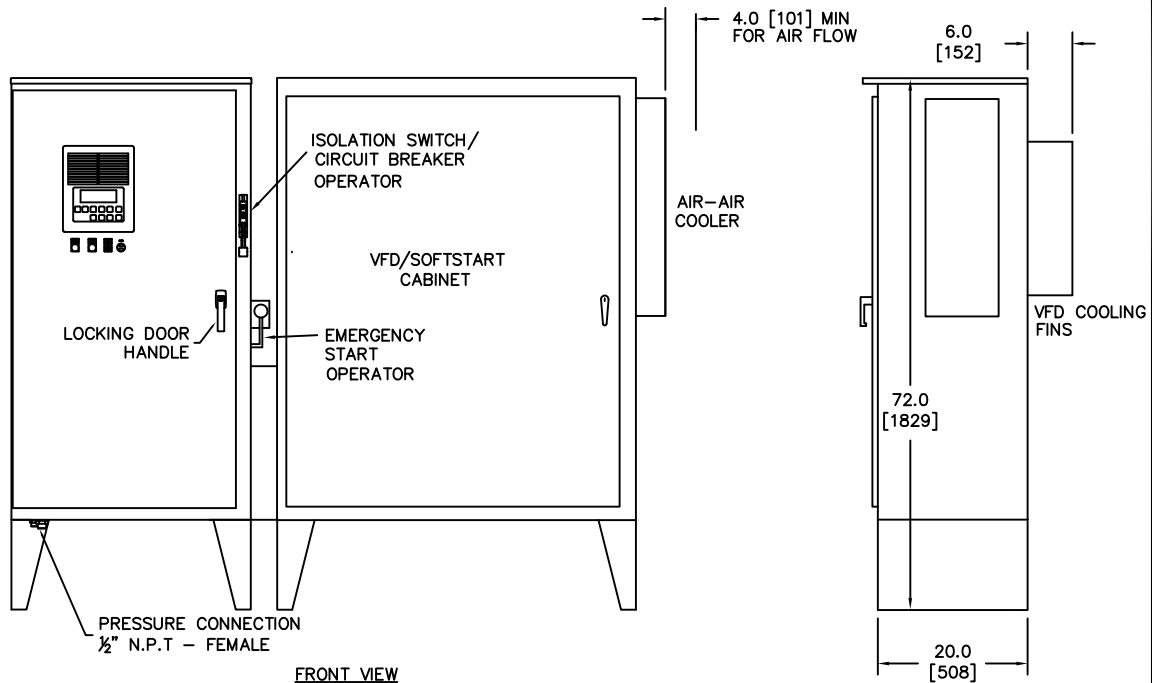

FRONT VIEW

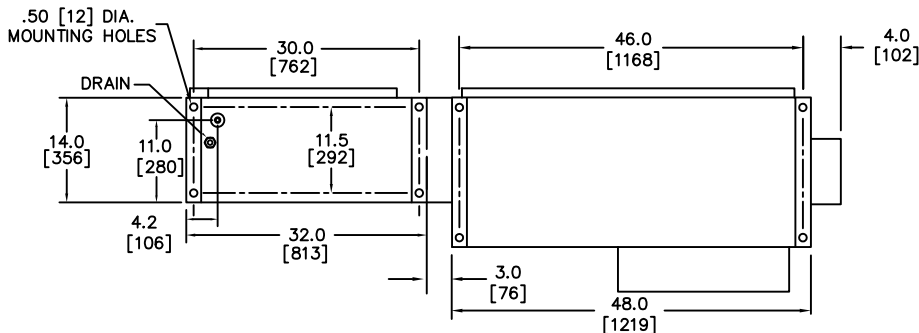

BOTTOM VIEW

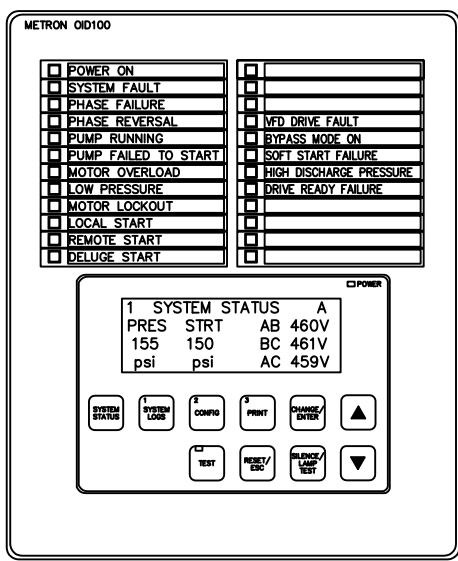

VOLTAGE	HORSEPOWER
200V	15-60
208V	15-75
230V	15-75
380V	NA
460V	NA

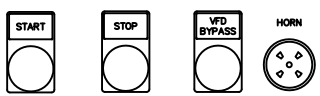

NEMA 12 ENCLOSURE.

DRAWN	RA	07-07-10
CHECK		
APPD	M.K.	07-07-10

METRON, INC.  
DENVER, CO.

ENCLOSURE DIMENSIONS  
MODEL MP800-700  
38" CABINET WITH VFD SIDE CUBE  
ELECTRIC FIRE PUMP CONTROLLER

CD34900A  
SCALE N.T.S. SHEET 1 OF 1

NOTES:  
ALL DIMENSIONS IN INCHES  
AND MILLIMETERS ([ ])

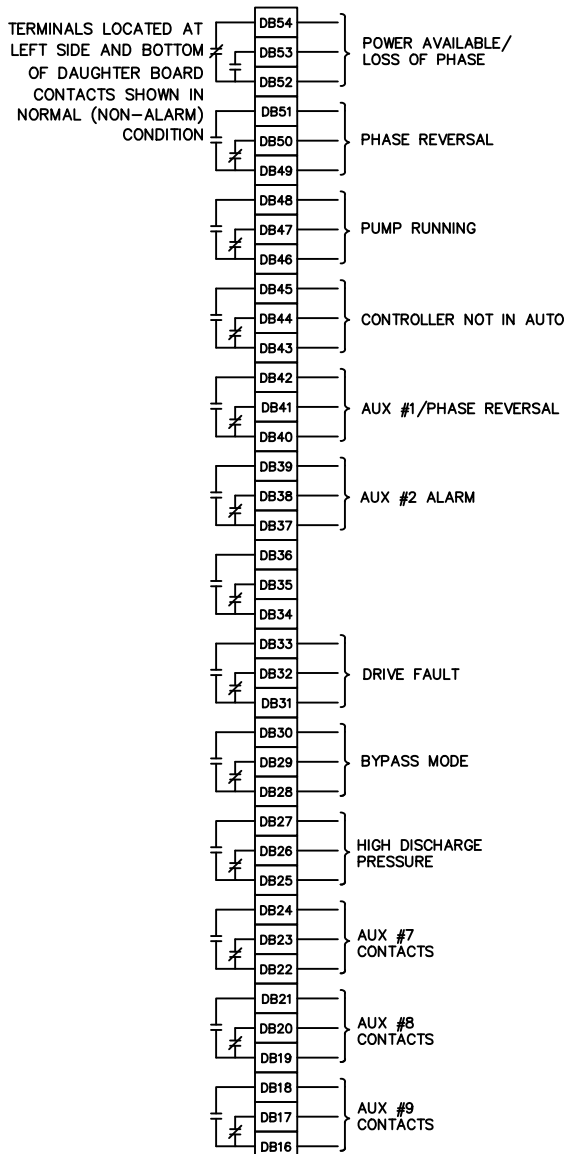
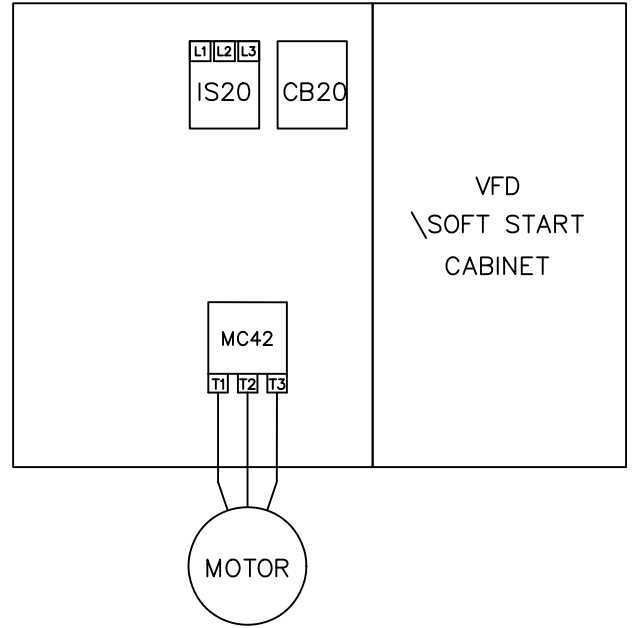
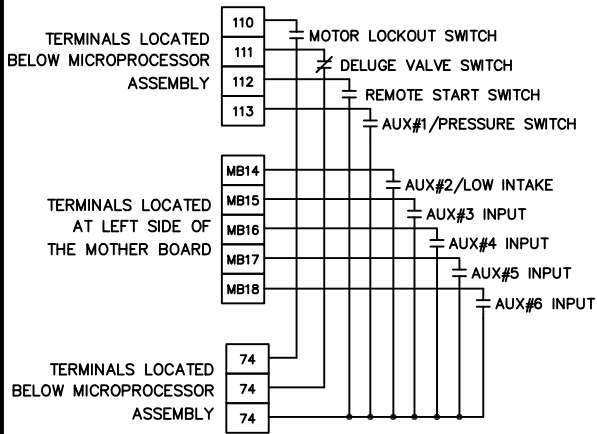

NOTES:

1. MOTOR TERMINATIONS VARY WIDELY BETWEEN MANUFACTURERS. PLEASE REFER TO MOTOR CONNECTION DIAGRAM ON THE MOTOR FOR VERIFICATION.
2. PROPER PHASE SEQUENCE MUST BE OBSERVED. A,B,C – L1,L2,L3 AS CONTROLLER IS PHASE SEQUENCE SENSITIVE
3. INCOMING CABLE SIZE TO BE 125% OF MOTOR FULL LOAD CURRENT. REFER TO WIRE SIZE TABLES IN NFPA 70.

	VOLTS AC					PRIMARY WIRE SIZE	
	200V	208V	220V – 240V	380V – 415V	440V – 480V	LINE TERMINAL WIRE SIZE PER PHASE	SERVICE ENTRANCE GROUND LUG WIRE SIZE
MAXIMUM MOTOR HORSEPOWER	25 HP	25 HP	30 HP	50 HP	60 HP	#14-1/0 AWG	(2) #10-1/0 AWG
	40 HP	40 HP	50 HP	75 HP	100 HP	#4-3/0 AWG	(2) #10-1/0 AWG
	60 HP	75 HP	75 HP	125 HP	150 HP	#3/0-350 MCM	(2) #10-1/0 AWG

EXTERNAL HOOKUP DIAGRAM MODEL MP800-SOFT START BYPASS ELECTRIC FIRE PUMP CONTROLLER	DRAWN <i>RL</i> 07-09-10	<b>METRON, INC.</b> DENVER, CO.
	CHECK	
	APPD	
OPTIONS: CH34778	SCALE N.T.S	SHEET 1 OF 1

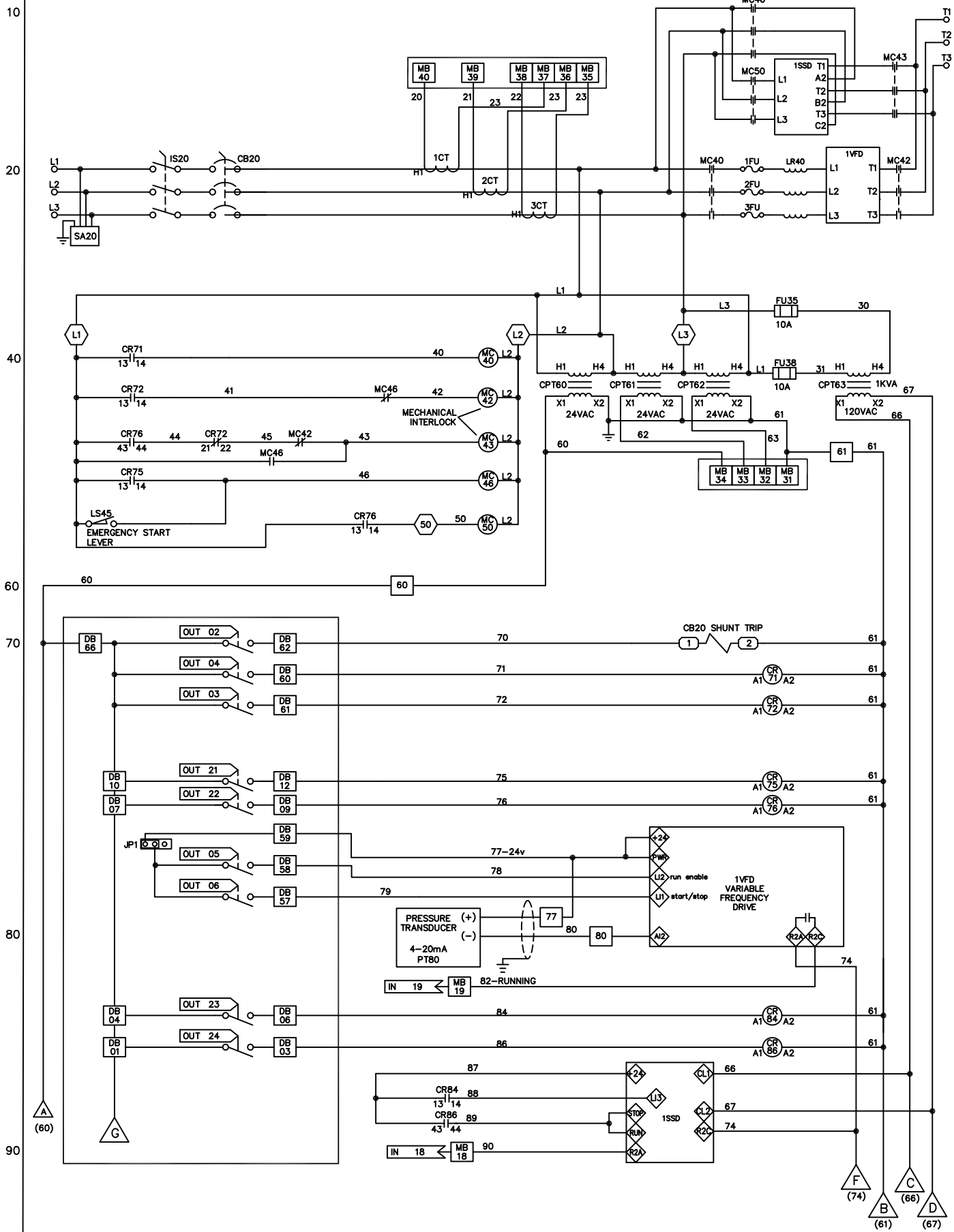

LEGEND:

- MB ## - MB = MB100 MOTHERBOARD I/O TERMINAL
- DB ## - DB = DB200 DAUGHTERBOARD I/O TERMINAL
- 1 - WIRES OR TERMINALS LOCATED ON CIRCUIT BREAKER

	DRAWN <i>RA</i> 02-14-06	<b>METRON, INC.</b> DENVER, CO.
	CHECK	
	APPD <i>ML JC</i> 03-24-07	
SCHEMATIC, MODEL MP800 VARIABLE FREQUENCY DRIVE ELECTRIC FPC W/SOFT START BYPASS		OPTIONS: CS34081A
		SCALE NTS SHEET 1 OF 3

100

110

120

130

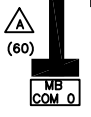
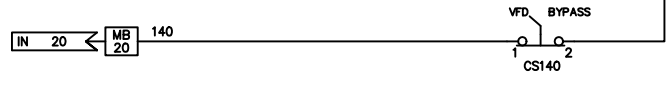
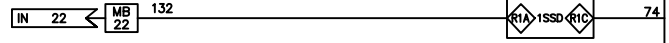
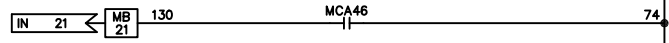
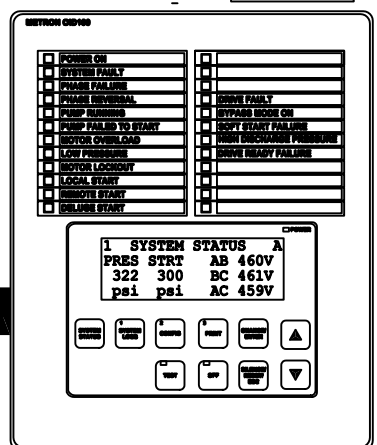
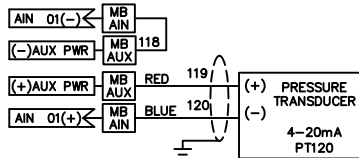
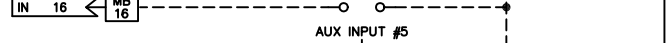
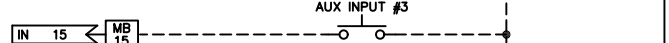
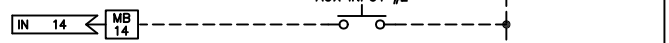
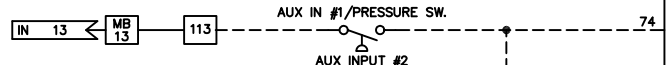
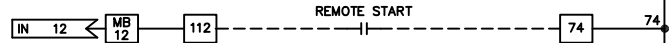
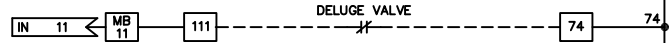
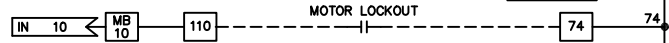
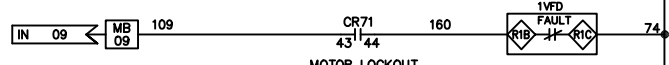
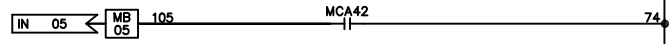
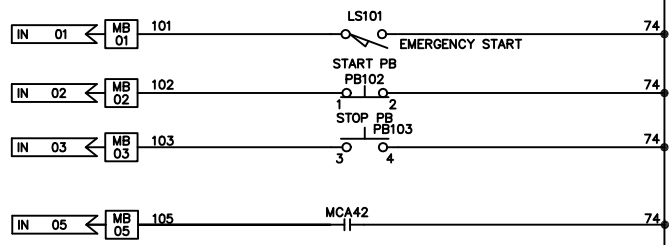
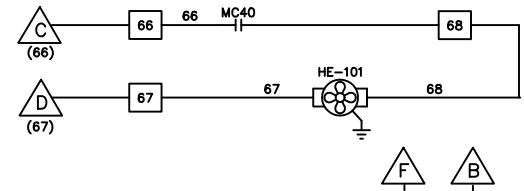
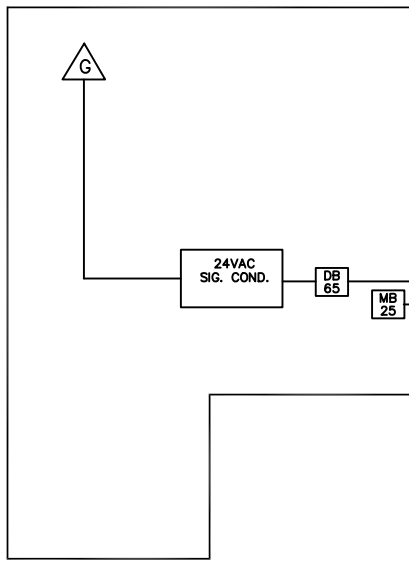

LEGEND:

MB ## - MB = MB100 MOTHERBOARD I/O TERMINAL

DB ## - DB = DB200 DAUGHTERBOARD I/O TERMINAL

(1) - WIRES OR TERMINALS LOCATED ON CIRCUIT BREAKER

SCHEMATIC, MODEL MP800 VARIABLE FREQUENCY DRIVE ELECTRIC FPC W/SOFT START BYPASS	DRAWN #2 02-14-06	<b>METRON, INC.</b> DENVER, CO.
	CHECK	
	APPD 77L.3C. 03-24-07	
	OPTIONS:H	
	CS34081A	
	SCALE NTS	SHEET 2 OF 3



200  
230  
240  
250  
260  
270

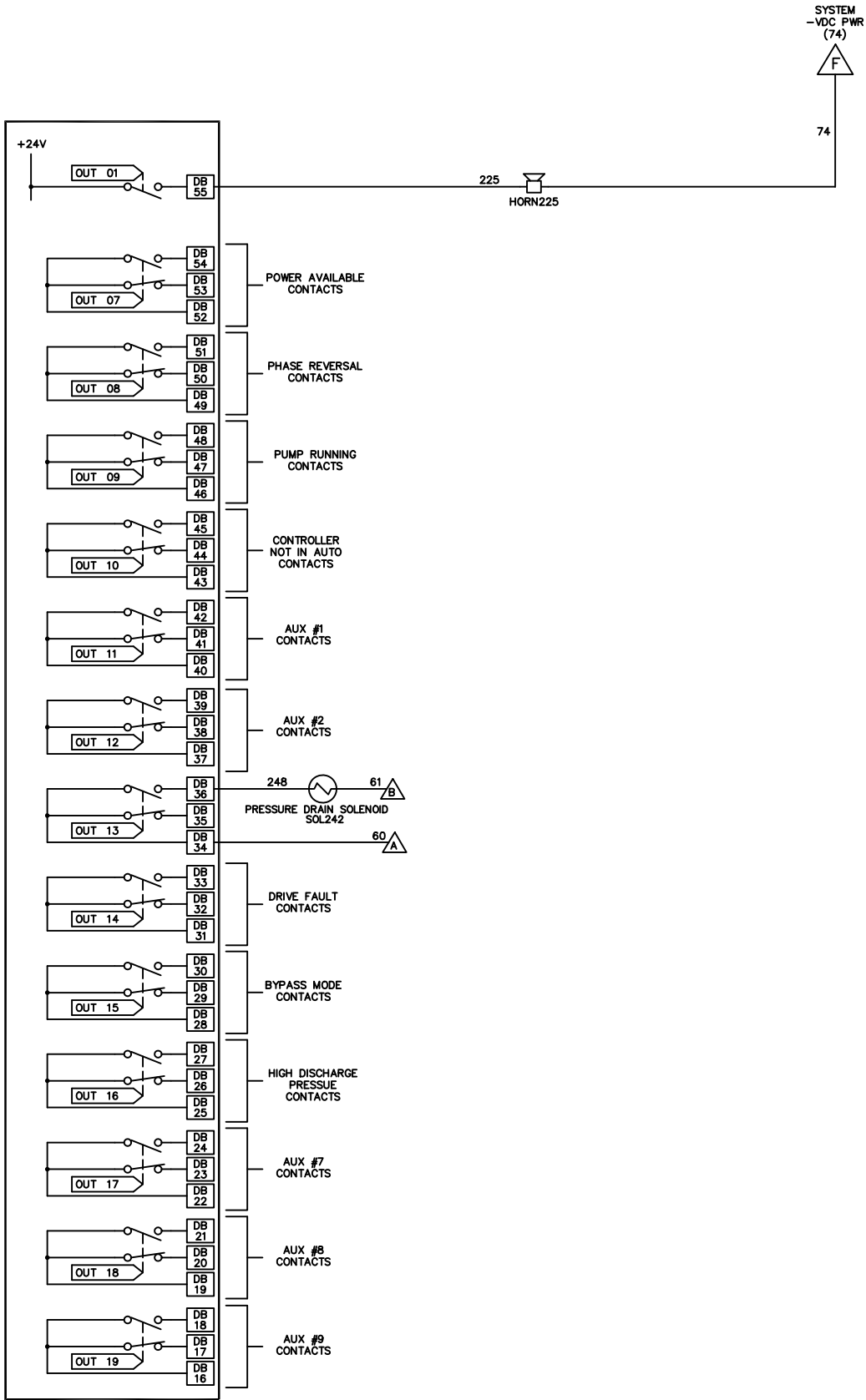

54A SOFT START DOES NOT UTILIZE A COOLING FAN AND ASSOCIATED CONTROL CIRCUIT. COOLING FAN TERMINAL NUMBERS ON SOFT START UNIT WILL VARY WITH MODEL USED.

	DRAWN <i>RL</i> 02-14-06	 <b>METRON, INC.</b> DENVER, CO.
	CHECK	
	APPD <i>MLK</i> 03-24-07	
SCHEMATIC, MODEL MP800 VARIABLE FREQUENCY DRIVE ELECTRIC FPC W/SOFT START BYPASS		OPTIONS: CS34081A
SCALE NTS	SHEET 3 OF 3	