

**NFPA13R Packaged Fire Pump System
UL/FM Fire Pump
with Jockey Pump**

13-ULV250-R

Compact Residential Package
Design Condition: 250GPM @ 40PSI

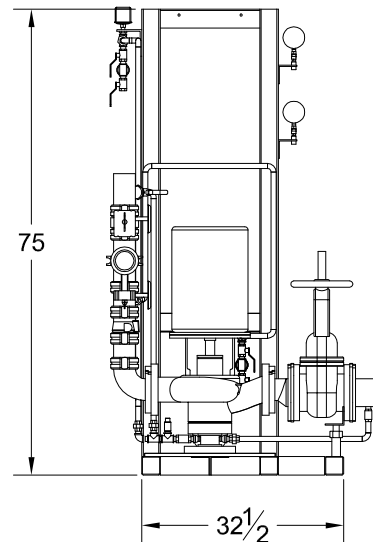
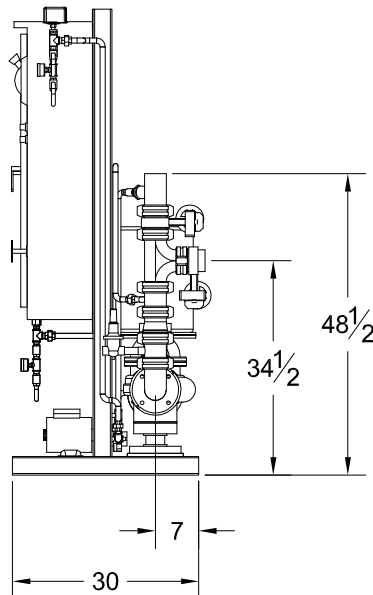
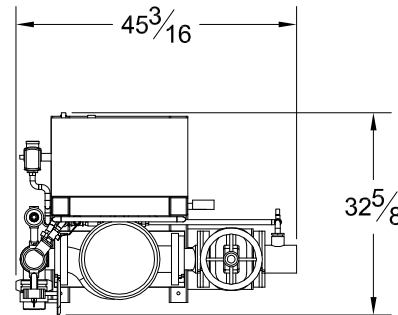
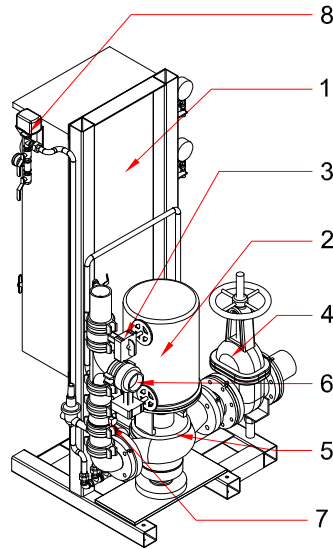

System Specifications:

- Motor**
- 10 Horsepower Electric
 - 230 Volt, 46 Amp
 - Single Phase
 - 3450 RPM

- Pump**
- UL/FM Vertical Inline Fire Pump
 - 4" Suction (Grooved)
 - 3" Discharge (Grooved)
 - 175 PSI max working pressure

System Components (UL Listed by Manufacturer)

- 1- Limited Service Fire Pump Controller
- 2- Electric Motor
- 3- Discharge Monitored Ball Valve
- 4- Suction OS&Y
- 5- Vertical Inline Fire Pump
- 6- Test Connection Monitored Ball Valve
- 7- Check Valve
- 8- Pressure Switch (Jockey Control)

Dimensions (Approximate)

- 33" Depth
- 75" Height
- 46" Width