

LSF-150SP

Compact Residential Package
50GPM @ 40PSI

System Specifications

Motor

- 1.5 Horsepower Electric
- 240 Volt, 10.9 Amp
- Single Phase
- 3450

Pump

- High Pressure Cast-Iron Volute
- 1 1/2" Suction
- 1 1/4" Discharge
- *75 PSI Max Working Pressure

Discharge Manifold

- Check Valve
- Zero to 100 PSI Pressure Gauge
- 30/50 Pressure Switch
- Isolation Ball Valve

Controls

- 240 Volt
- Minimum Run Timer
- Pressure Switch Operated Contactor
- HOA Toggle Switch (Hand, Off, Auto)

Dimensions (Approximate)

- 23 1/16" Length
- 19 3/4" Height
- 12 7/8" Width
- 73 Pounds

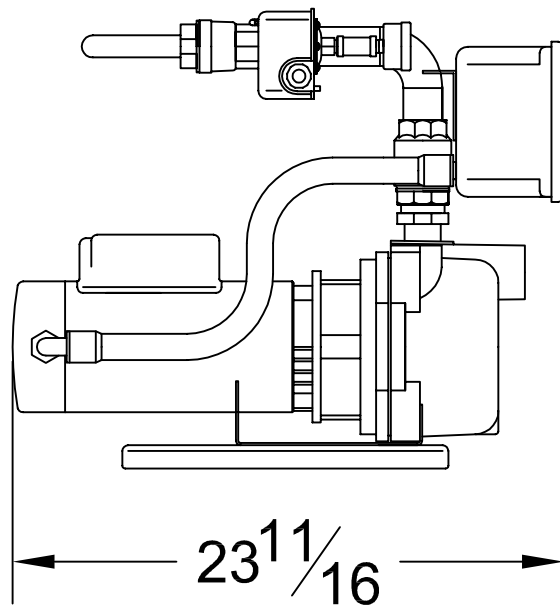
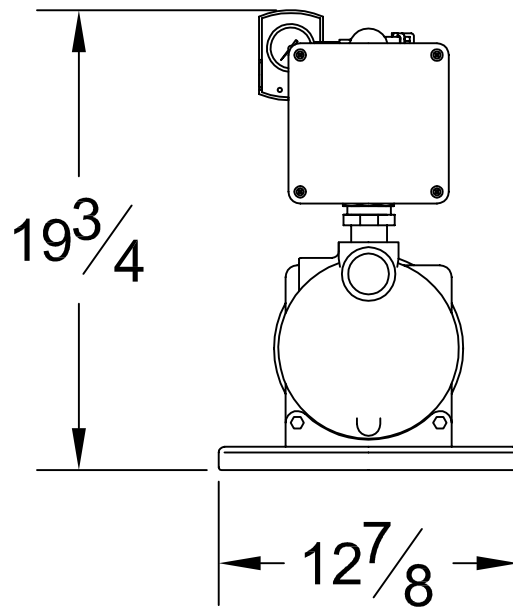

Performance

Performance values based on multiple pump tests. Not for certification purposes.

GPM	0	20	25	30	35	40	45	50
PSI	55	52	51	50	48	46	43	40

* 75PSI Max Working Pressure - Not for Booster Service